

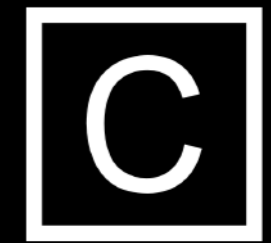

DETAILLERING.

DE KRIJGSMAN MUIDEN



COURAGE



wsp

 voortman



COURAGE

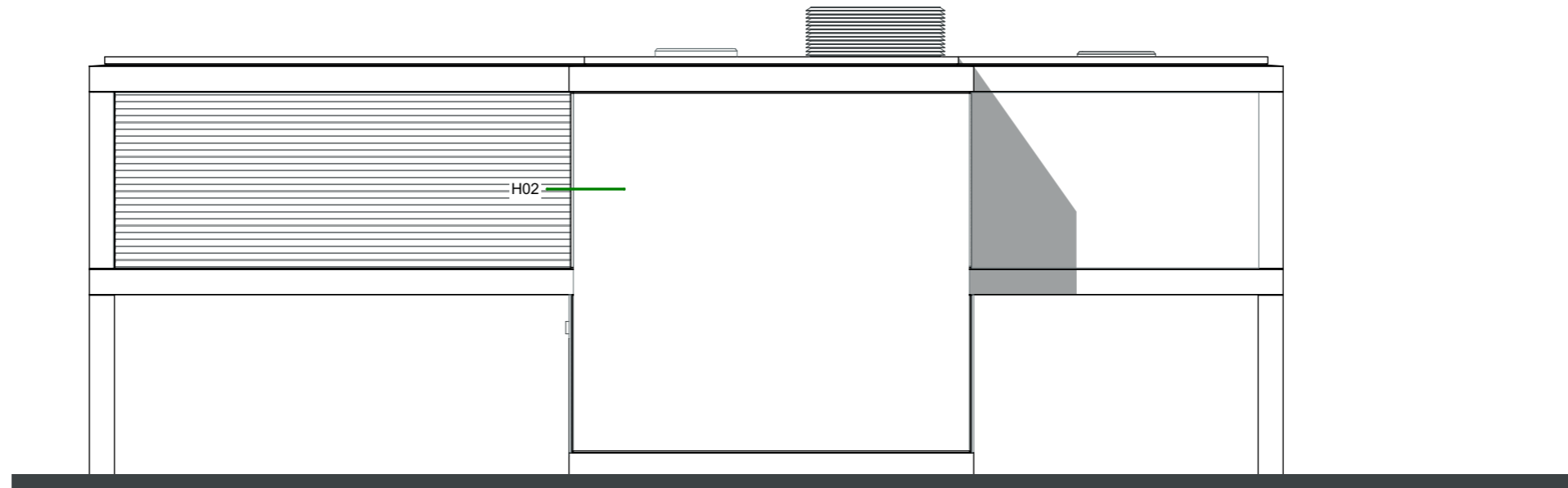

Voorgevel

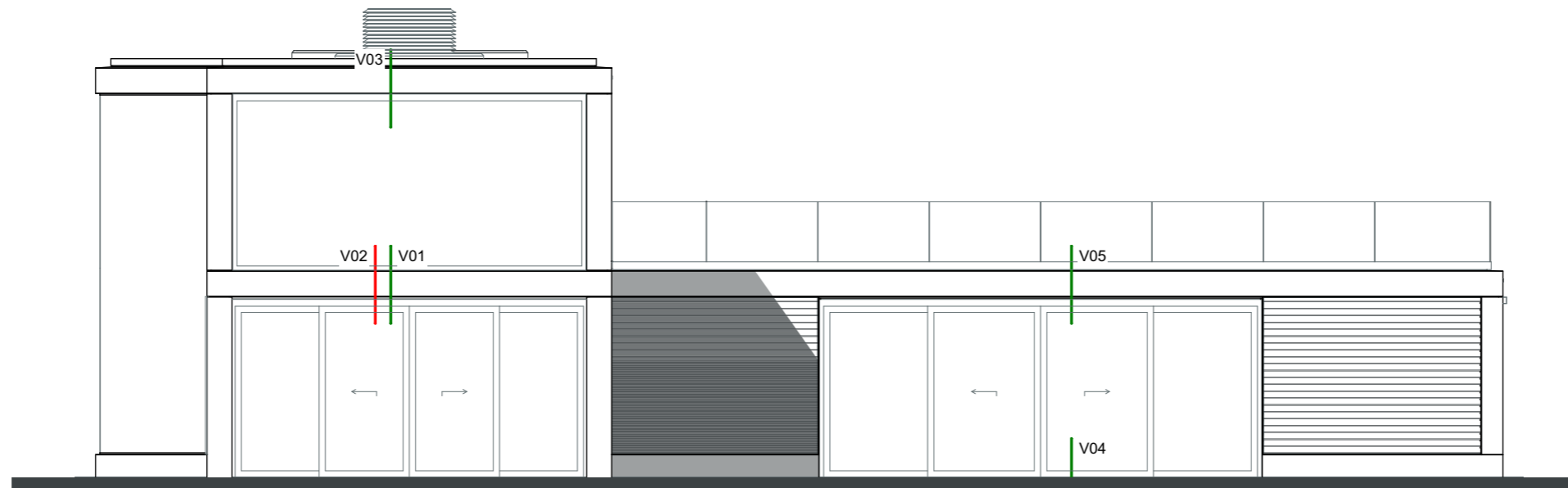

Rechtergevel

overzicht



COURAGE

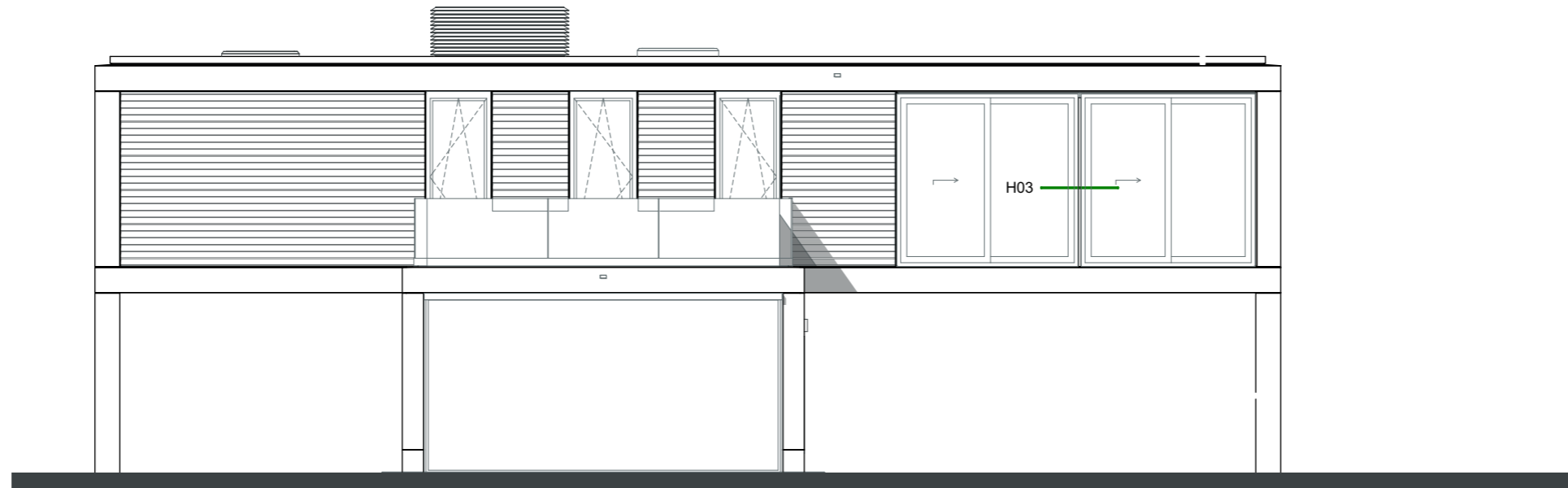

Achtergevel

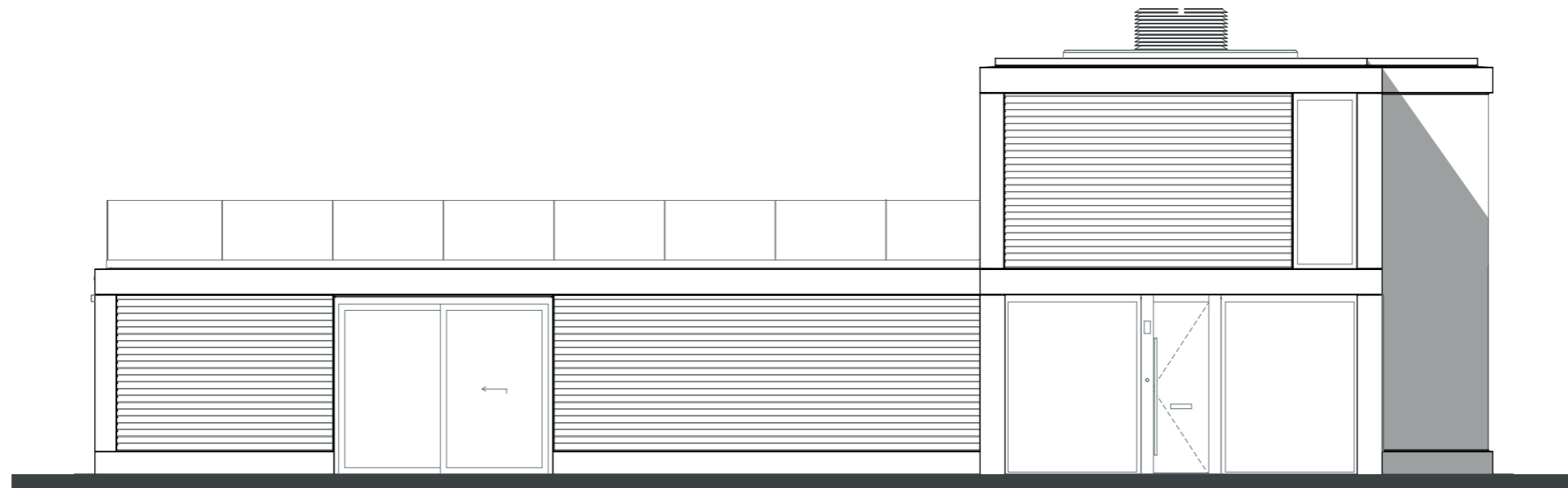

Linkergevel

overzicht



COURAGE

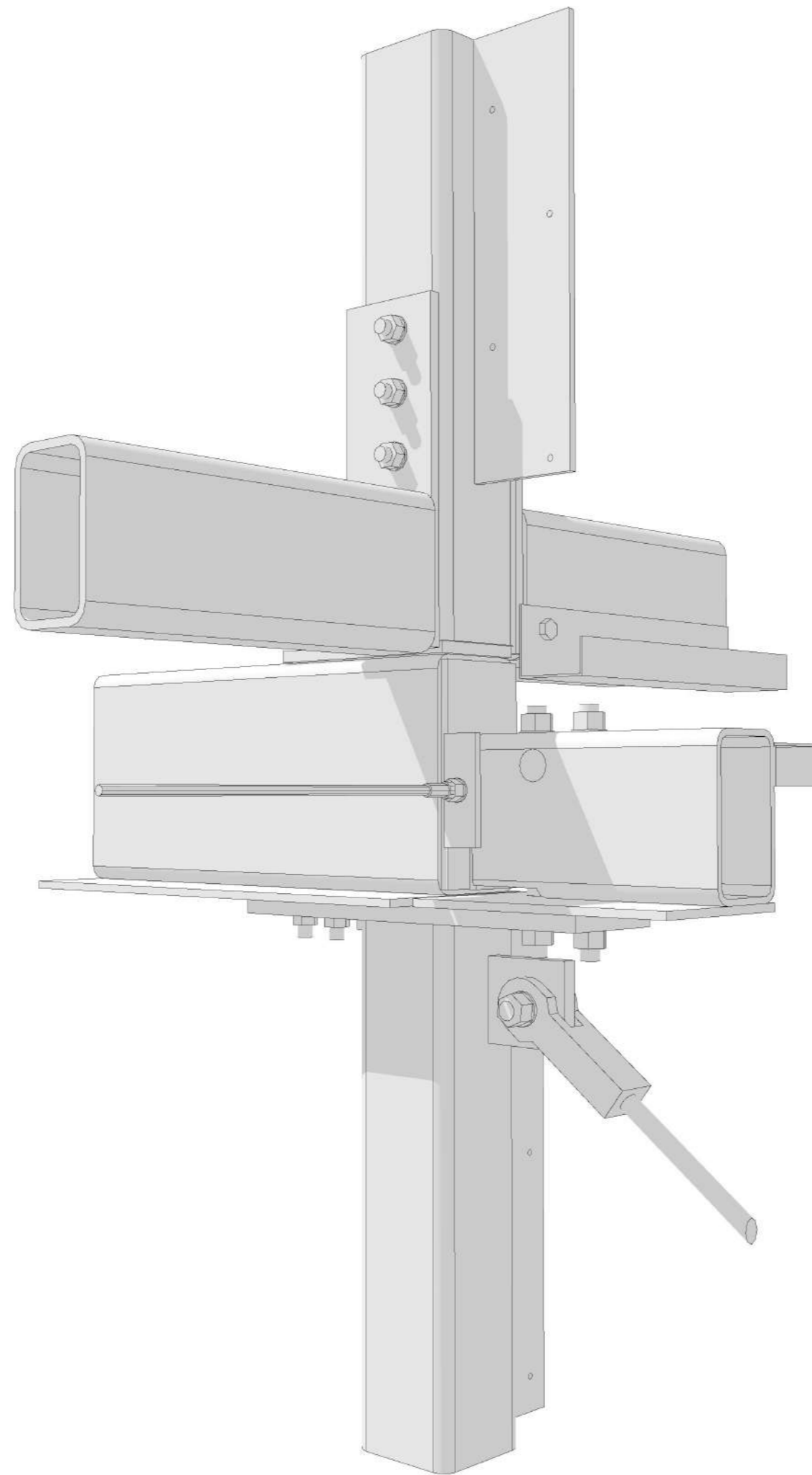

staalknooppunt



COURAGE

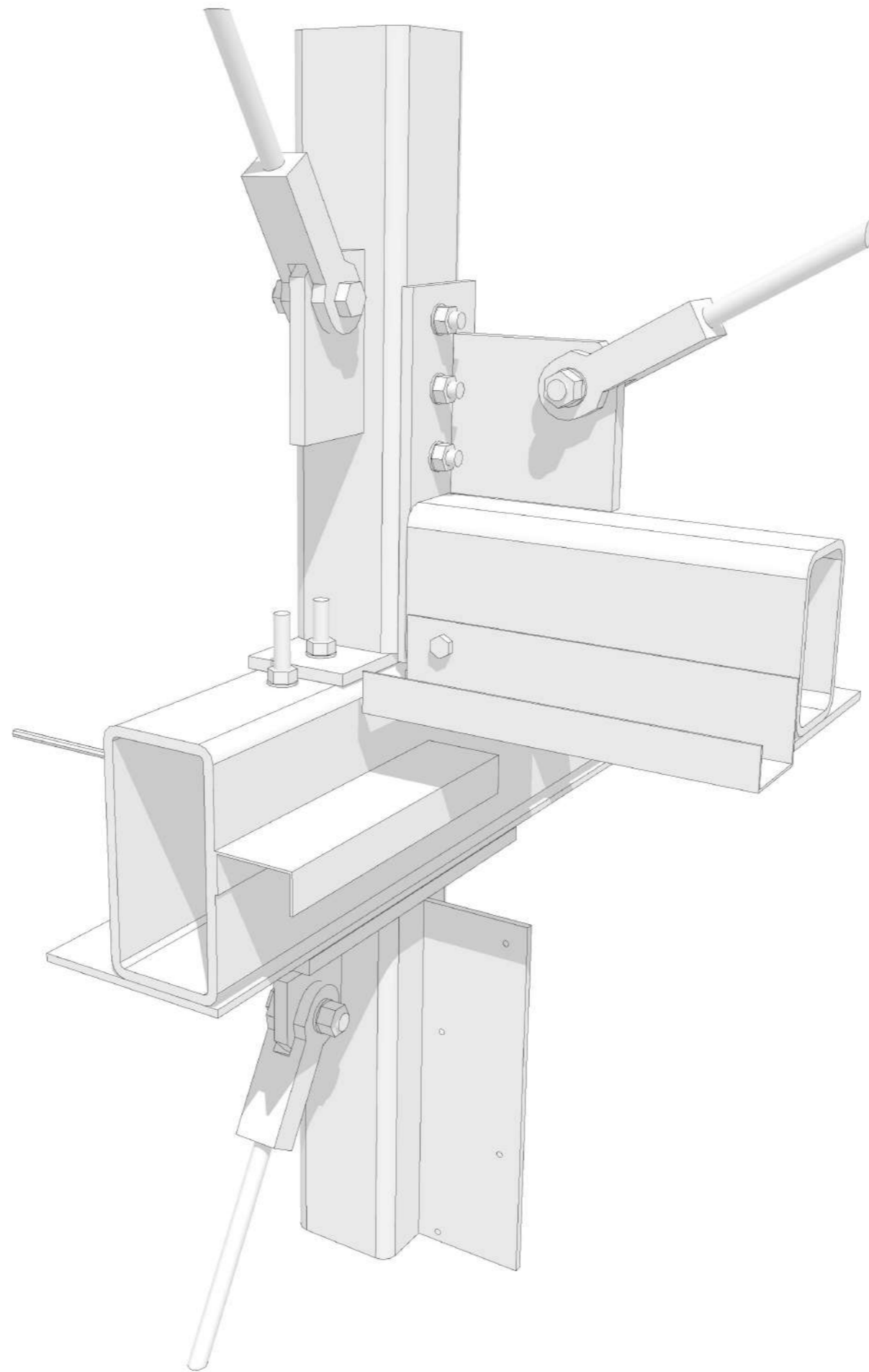

staalknooppunt



COURAGE

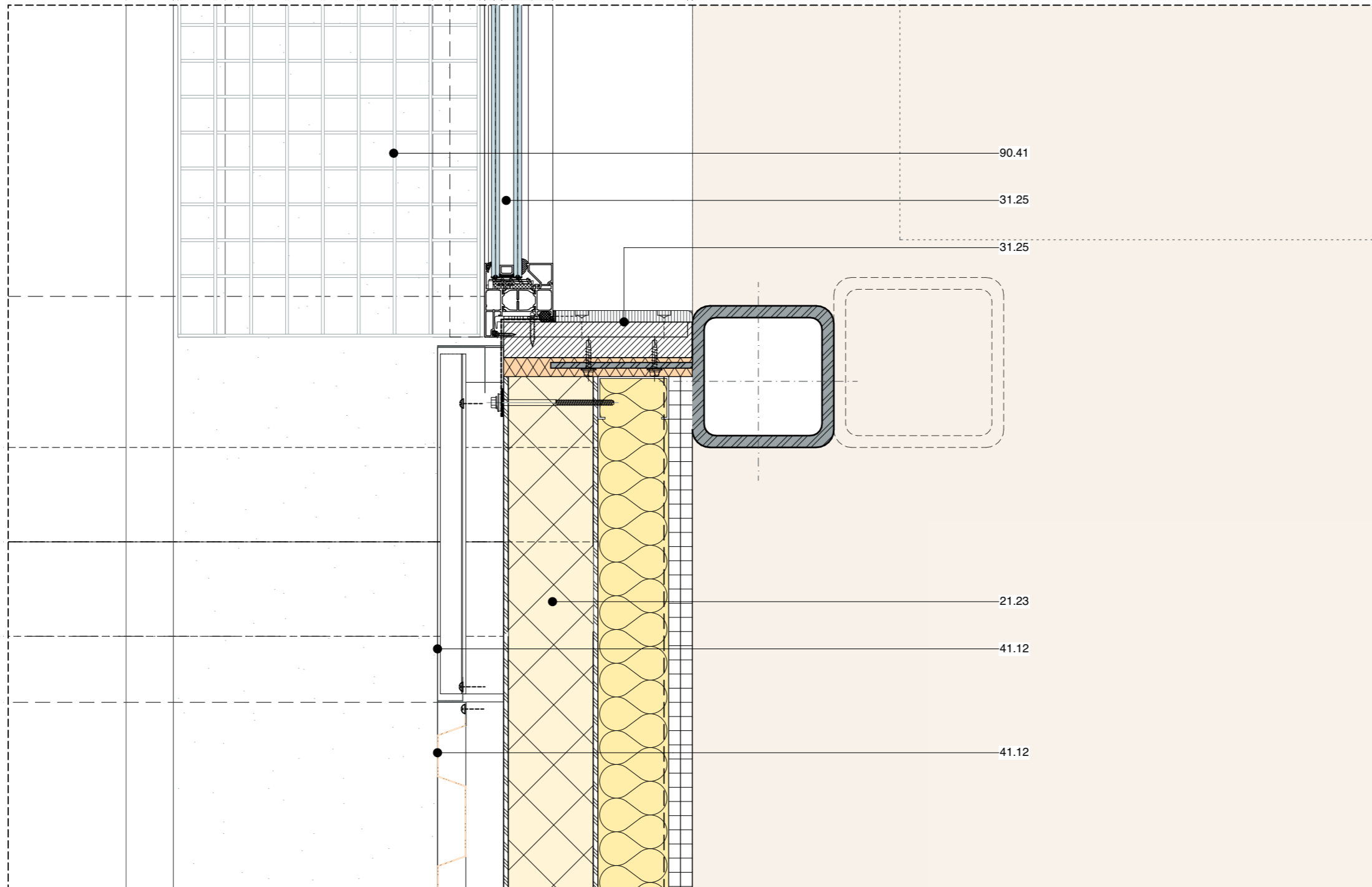

H01



COURAGE

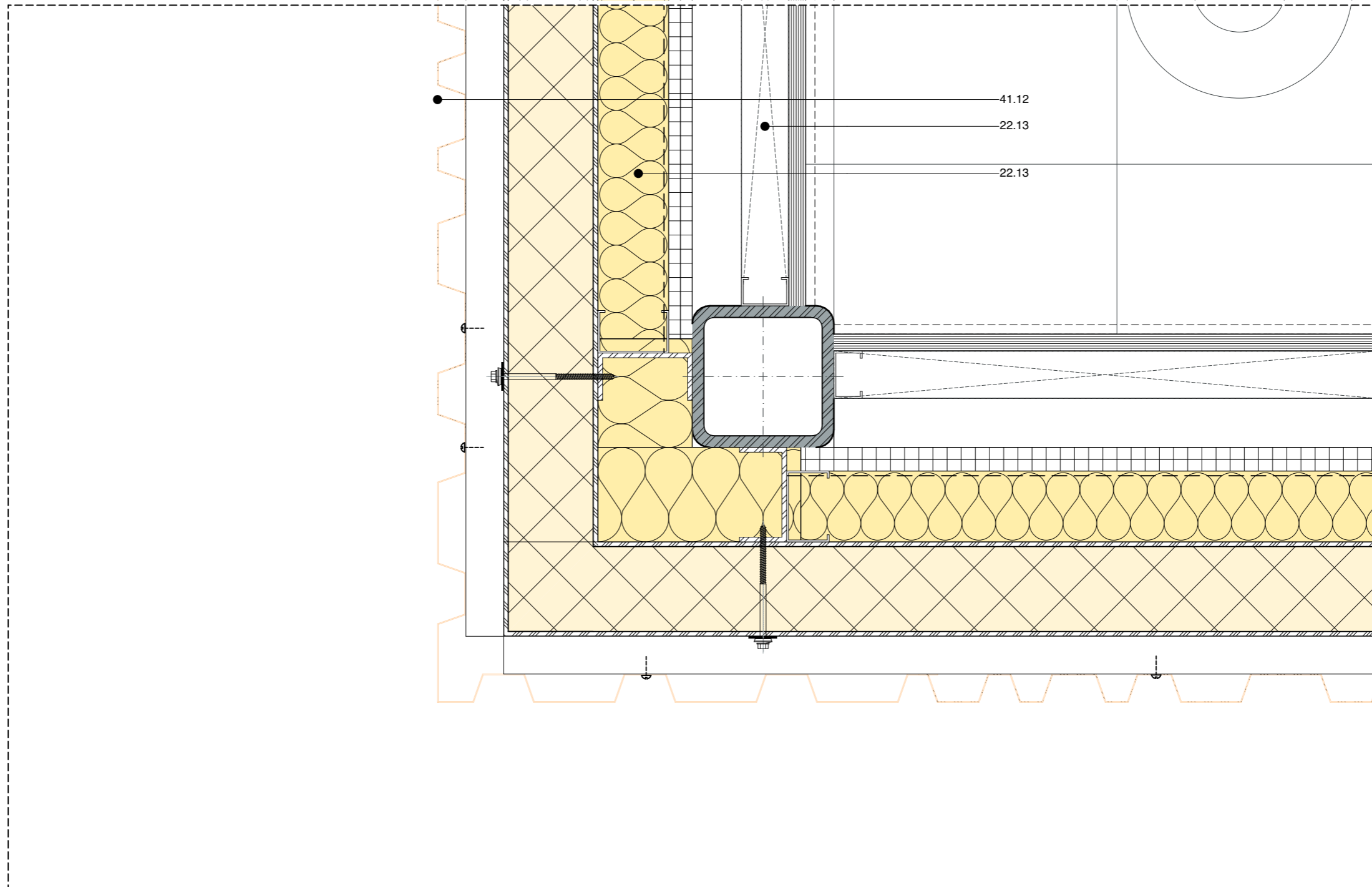

H02



COURAGE

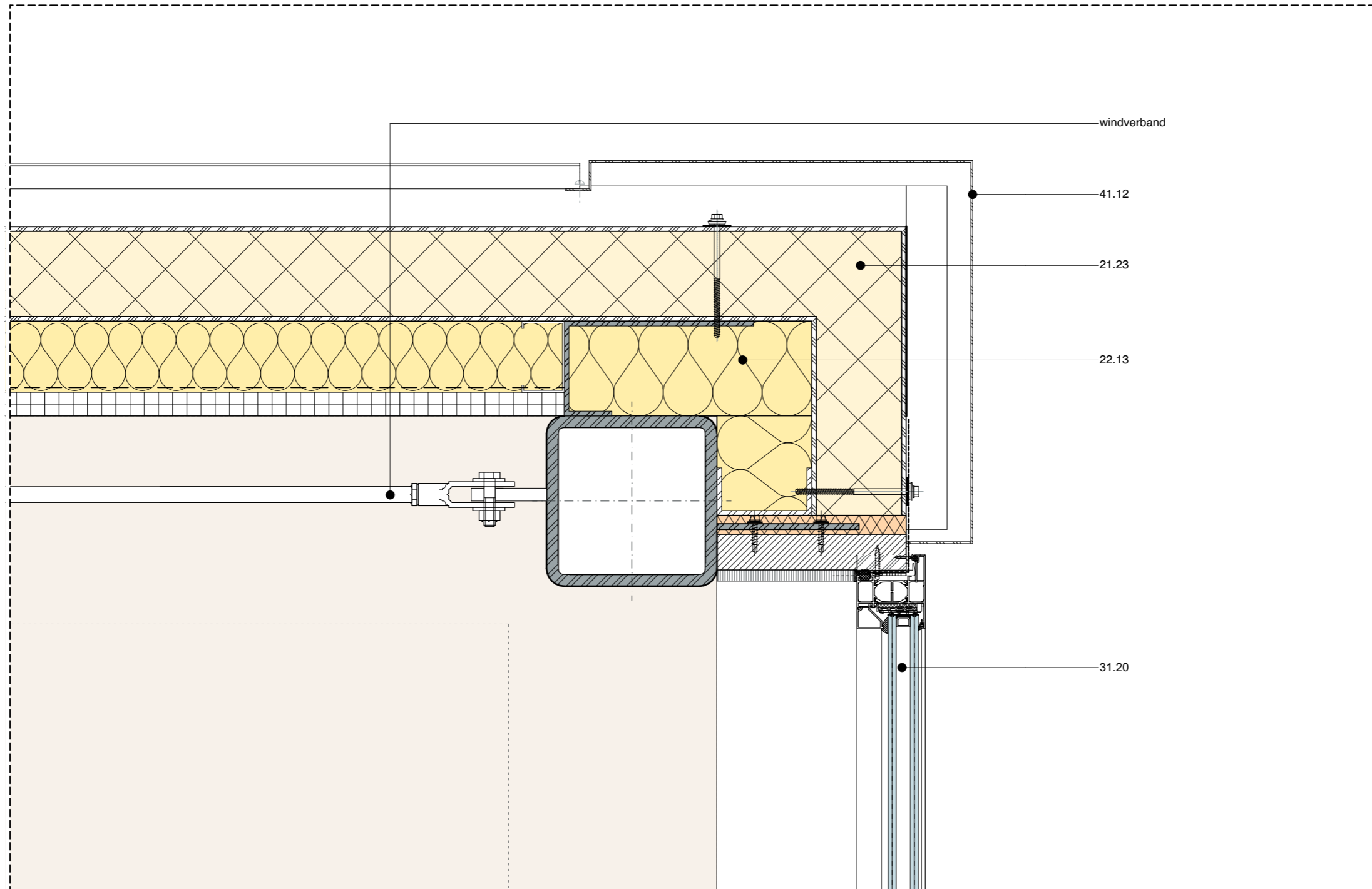

H03



COURAGE

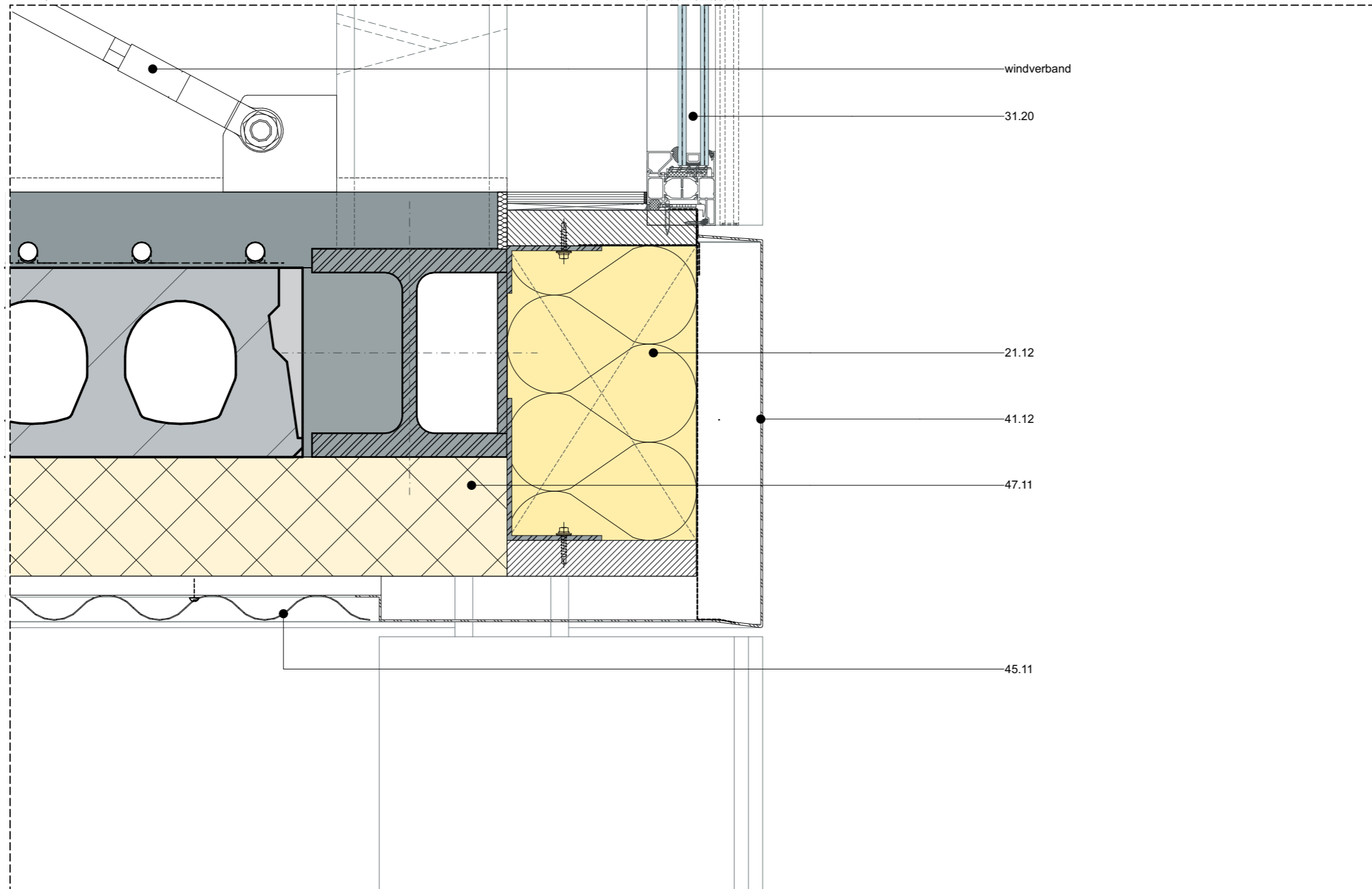

V01



COURAGE

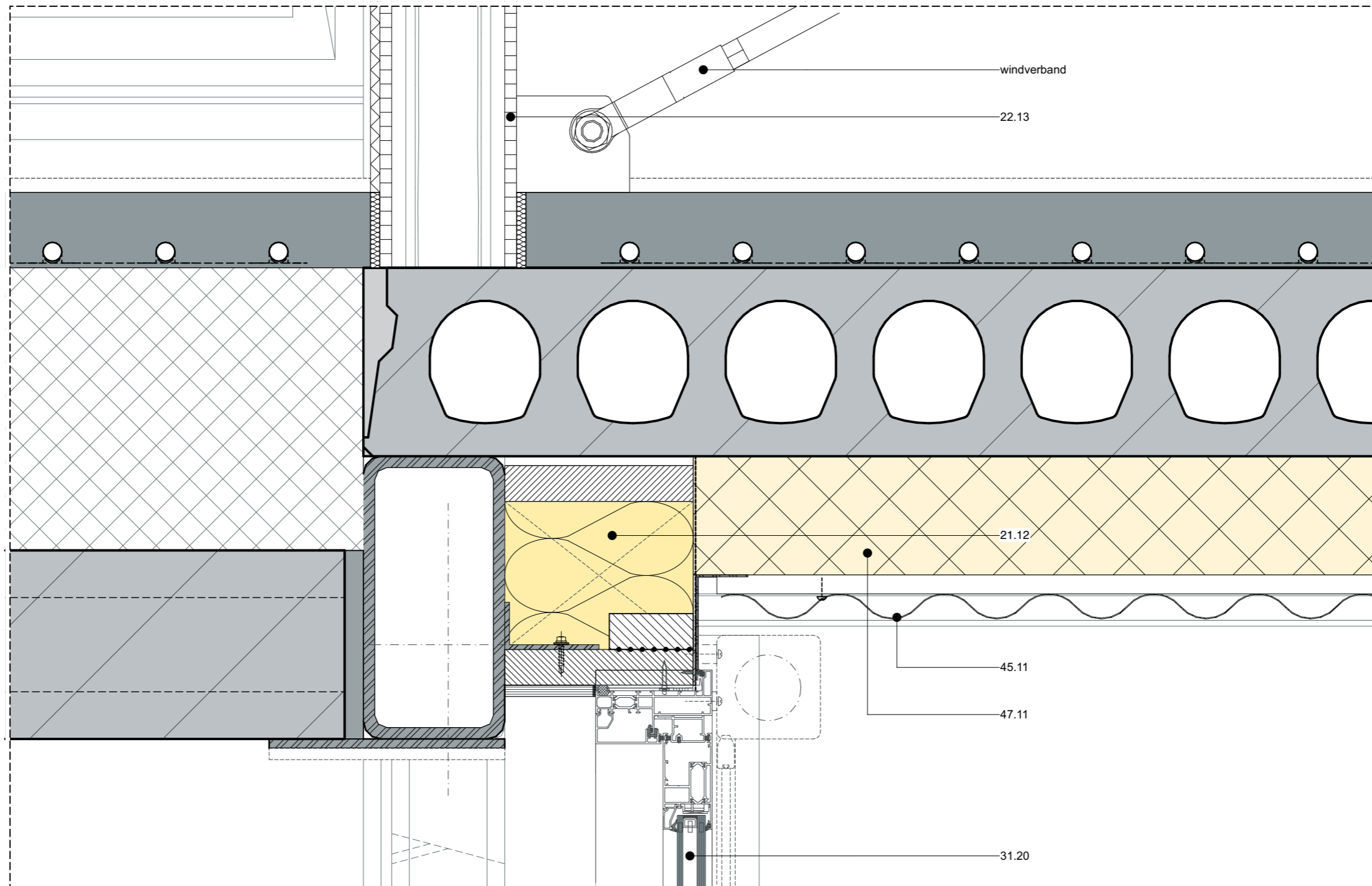

V02



COURAGE

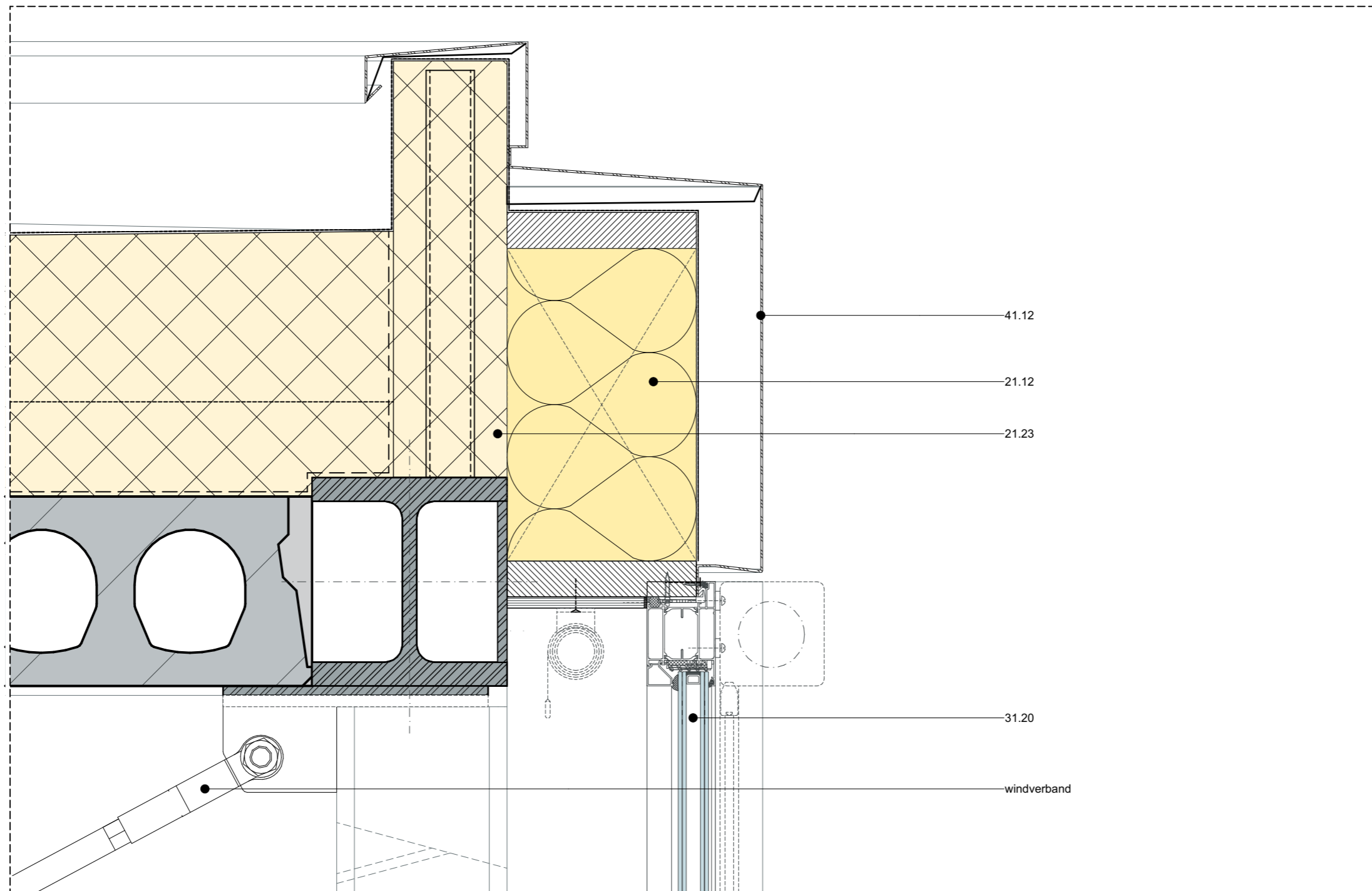

V03



COURAGE

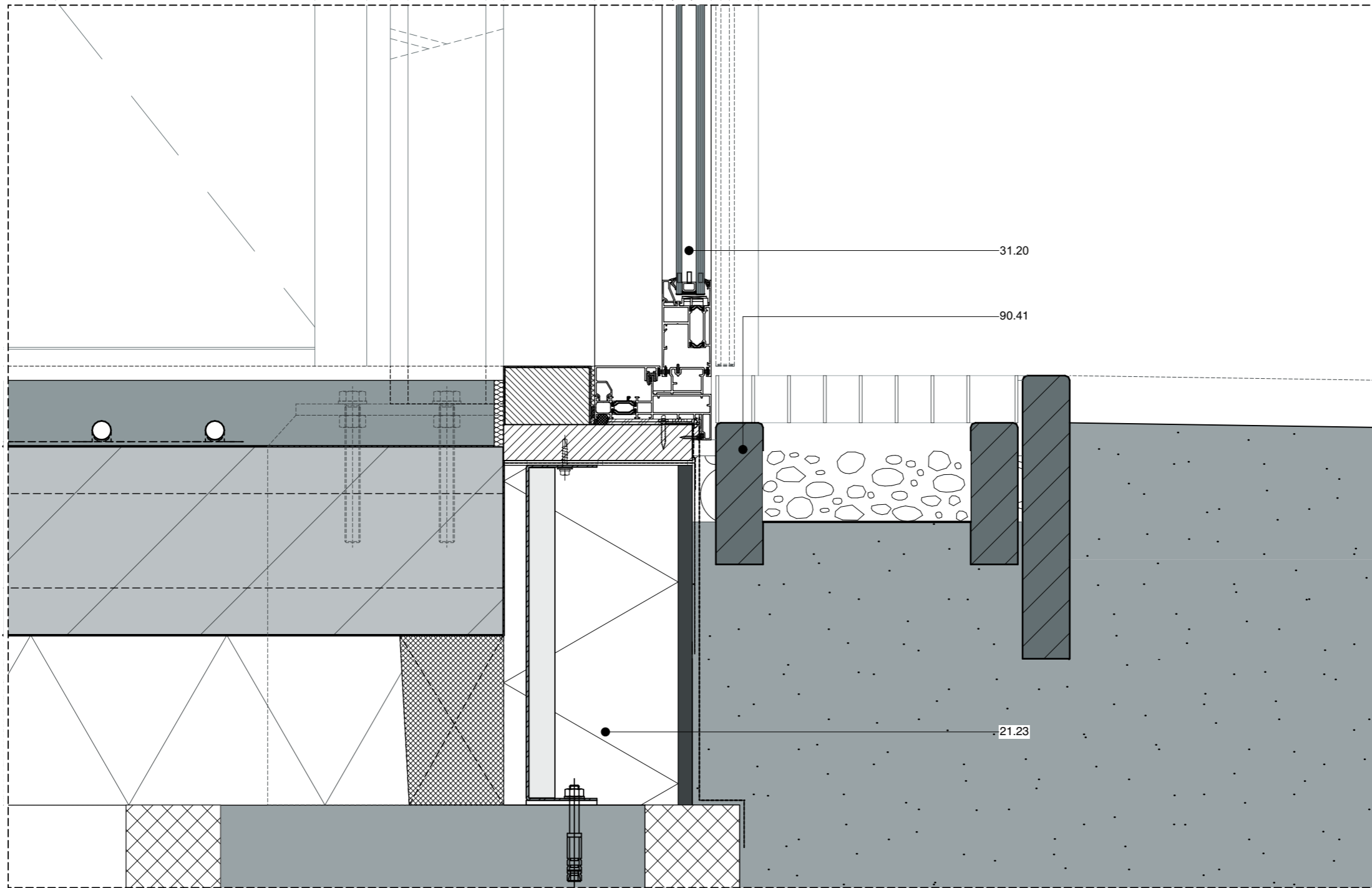

V04



COURAGE

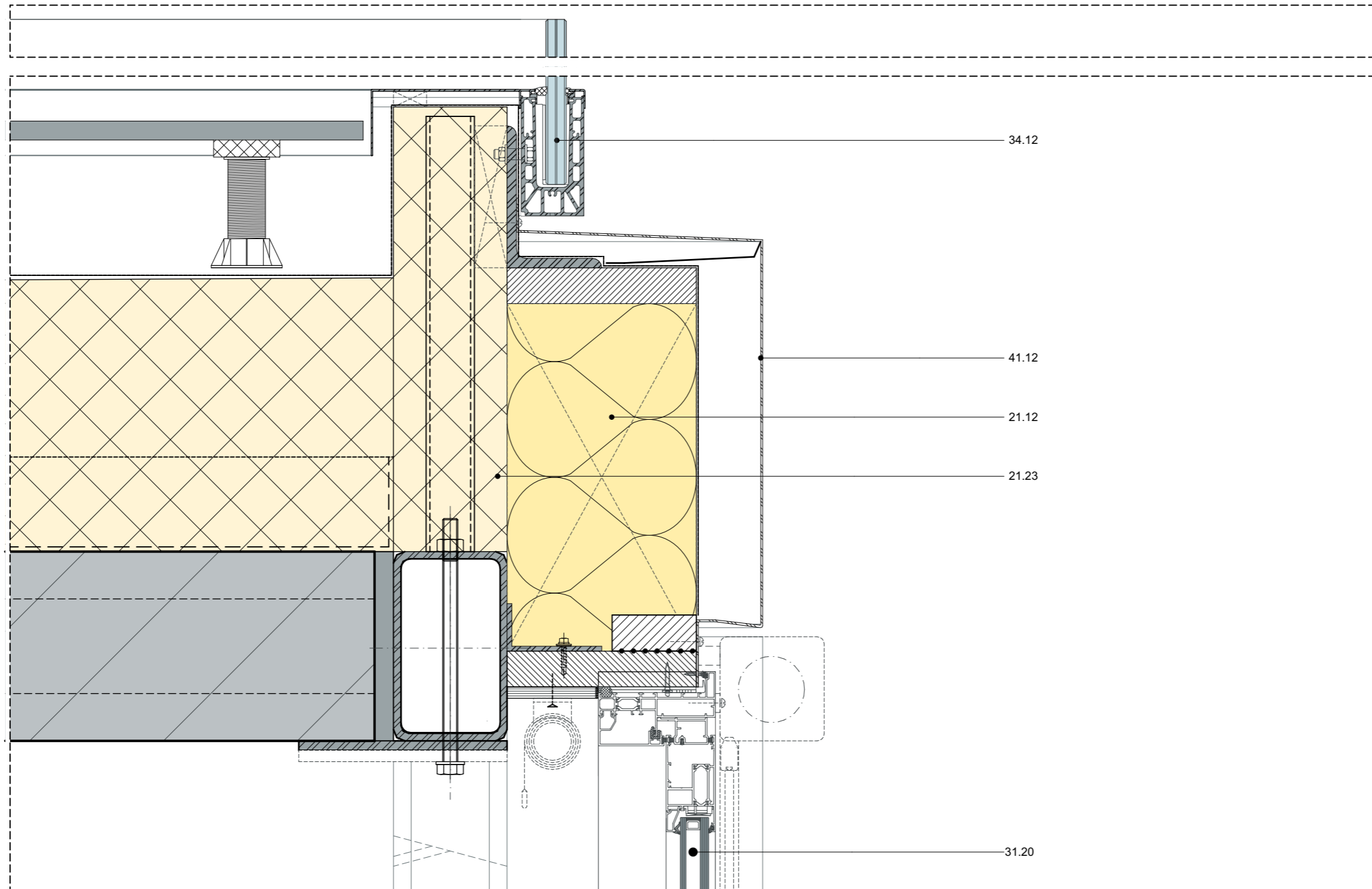

V05



COURAGE

- 21.12 spouwanden, rekwerk geïsoleerd
- 21.23 systeemwanden, sandwichpaneel PIR
- 22.13 systeemwanden vast, metalstudwand
- 31.25 combinatieramen
- 31.21 dagkantbekleding
- 34.12 buitenbalustrades, glashek, U-Zijmontage profiel
- 41.12 bekledingen, zetwerk
profielplaat - golf horizontaal
profielplaat - trapezium variabel
- 45.11 verlaagde plafonds, profielplaat - golf
- 47.11 vlakke dakafwerkingen, isolatie
- 90.41 verhardingen, opsluitband
verharding, roostervloer

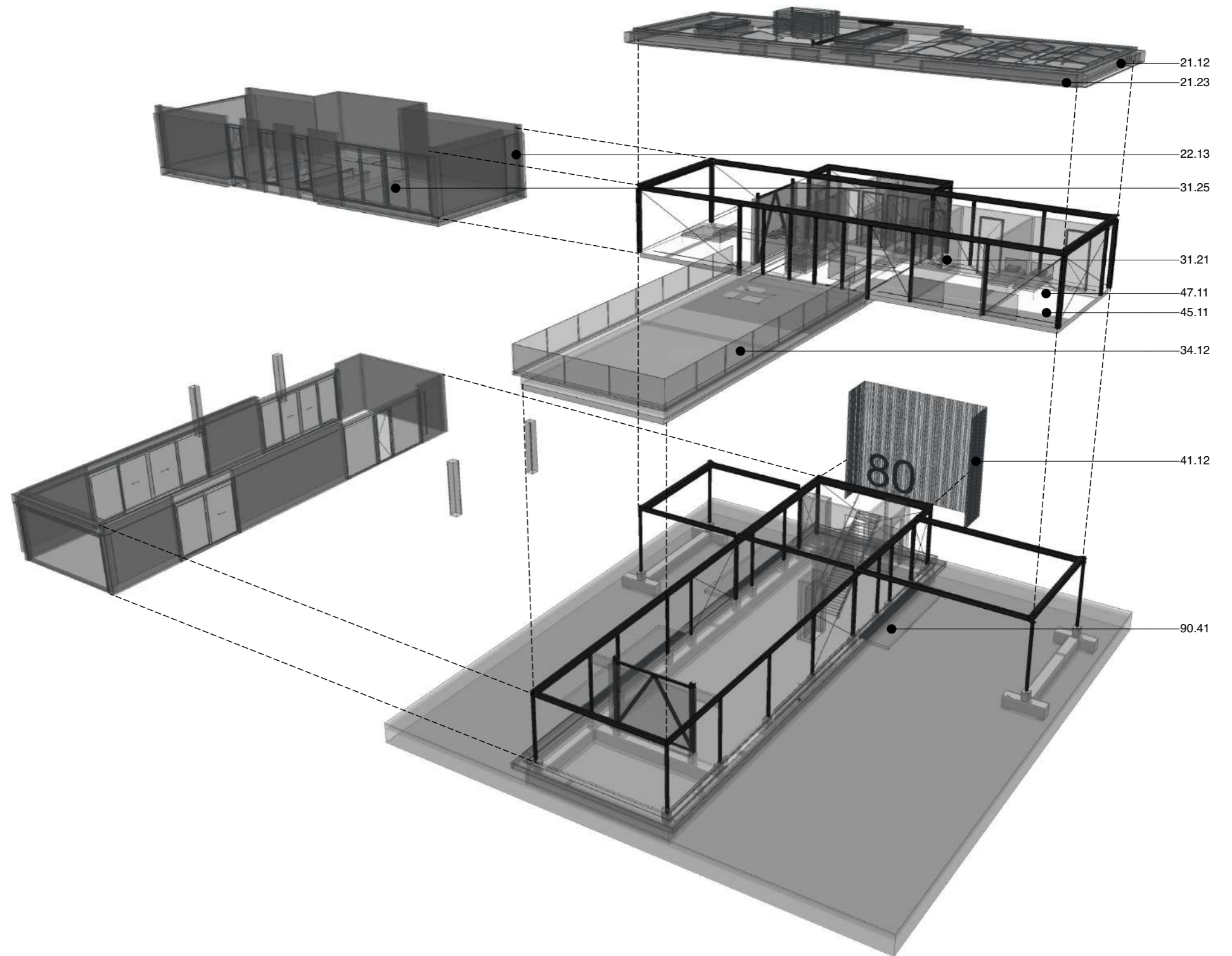

kleur- en materiaalstaat